

	Nominal Dimensions	Tolerance
Centreline Radius	38.1mm	Nominal
Overall Height	80.8mm	+/-1mm
Leg Length	30.00mm	Nominal
Wall Thickness	1.60mm	+0/-0.10mm

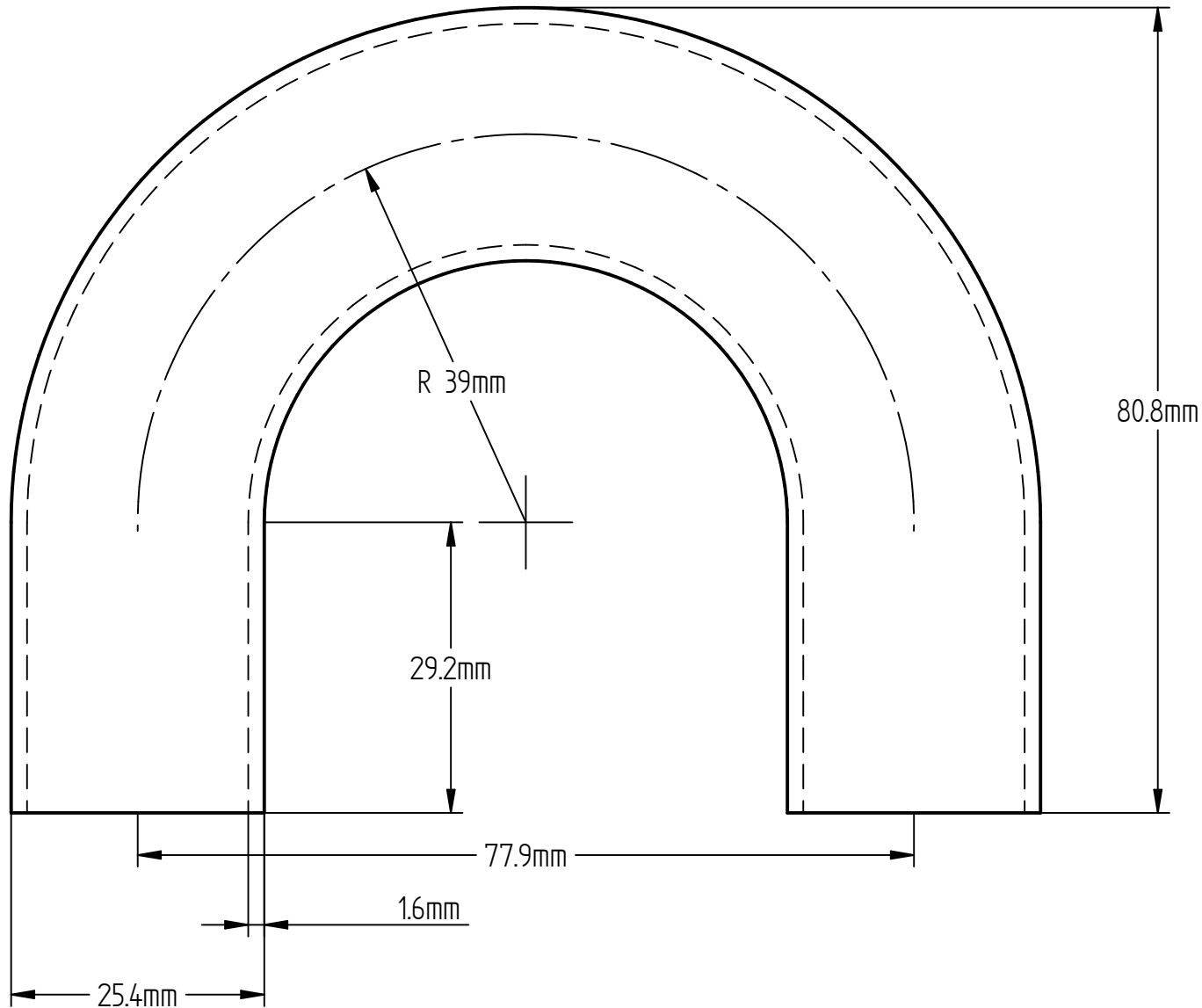

Ultibend INDUSTRIES INC		
TITLE 25.4 x 1.6mm 180 degree UNI Bend		
SIZE A4	DWG NO 106_8U	REV 001
Made to AS1528.3		Publish Date: 25/11/24
SCALE:	WEIGHT:	SHEET 1 OF 1