

	Nominal Dimensions	Tolerance
Centreline Radius	57.2mm	Nominal
Overall Height	120.9mm	+1/-0mm
Leg Length	47.8mm	Nominal
Wall Thickness	1.20mm	+0/-0.10mm

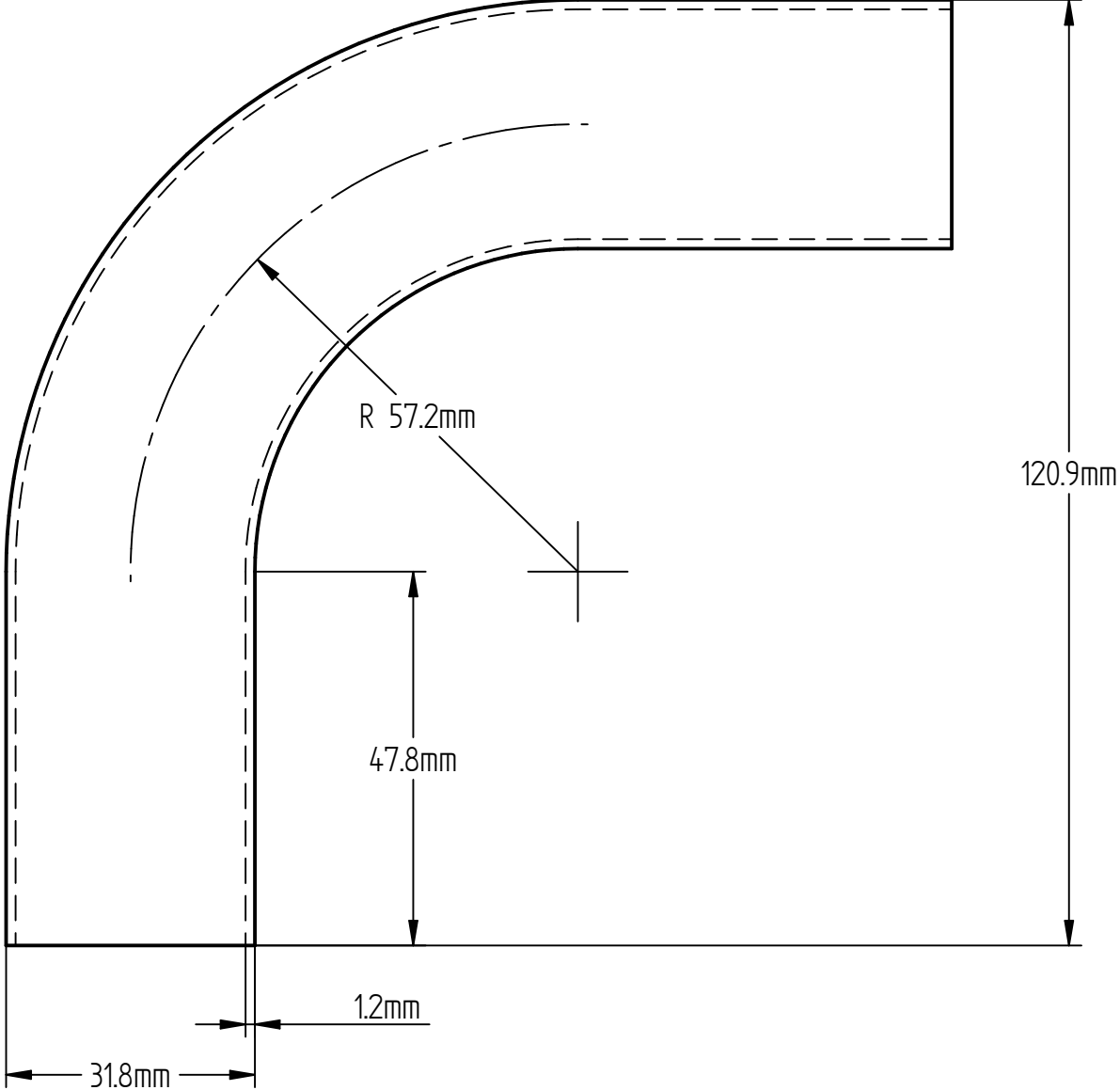

Ultibend INDUSTRIES INC		
TITLE 31.8 x 1.2mm 90 degree LL Bend		
SIZE A4	DWG NO 122_9L	REV 001
		Publish Date: 11/12/17
WEIGHT:		SHEET 1 OF 1