

	Nominal Dimensions	Tolerance
Centreline Radius	76.2mm	Nominal
Overall Height	130.2mm	+/-1mm
Leg Length	34.9mm	Nominal
Wall Thickness	1.60mm	+0/-0.10mm

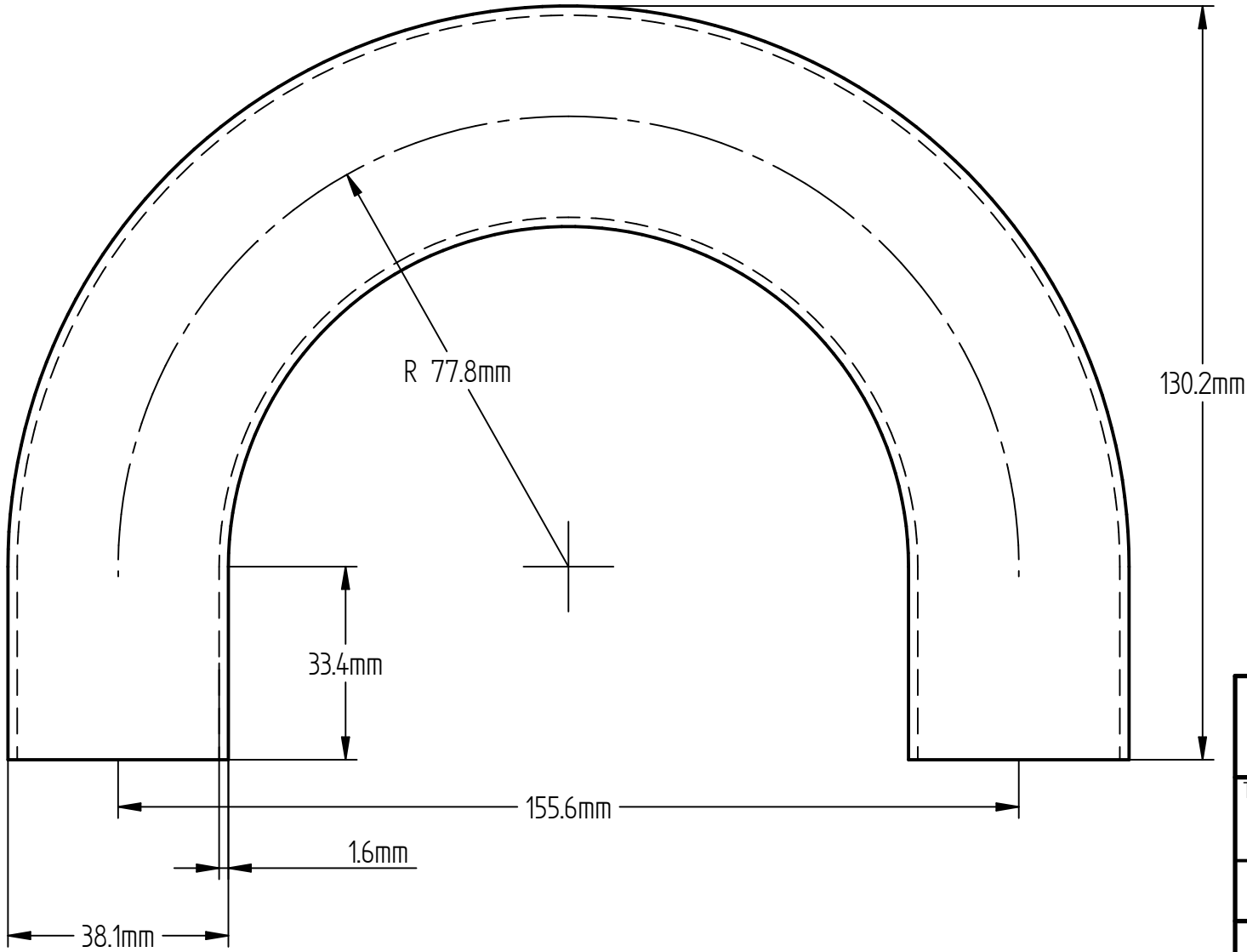

<b>Ultibend</b> INDUSTRIES INC		
TITLE 38.1 x 1.6mm 180 degree NZ Bend		
SIZE A4	DWG NO 156_8N	REV 001
		Publish Date: 25/11/24
SCALE:	WEIGHT:	SHEET 1 OF 1