

	Nominal Dimensions	Tolerance
Centreline Radius	51.4mm	Nominal
Overall Height	76.2mm	+1/-0mm
Leg Length	5.8mm	Nominal
Wall Thickness	1.50mm	+0/-0.10mm

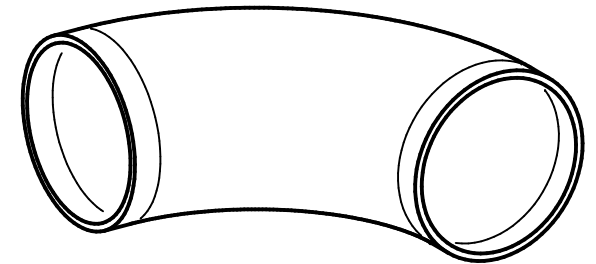
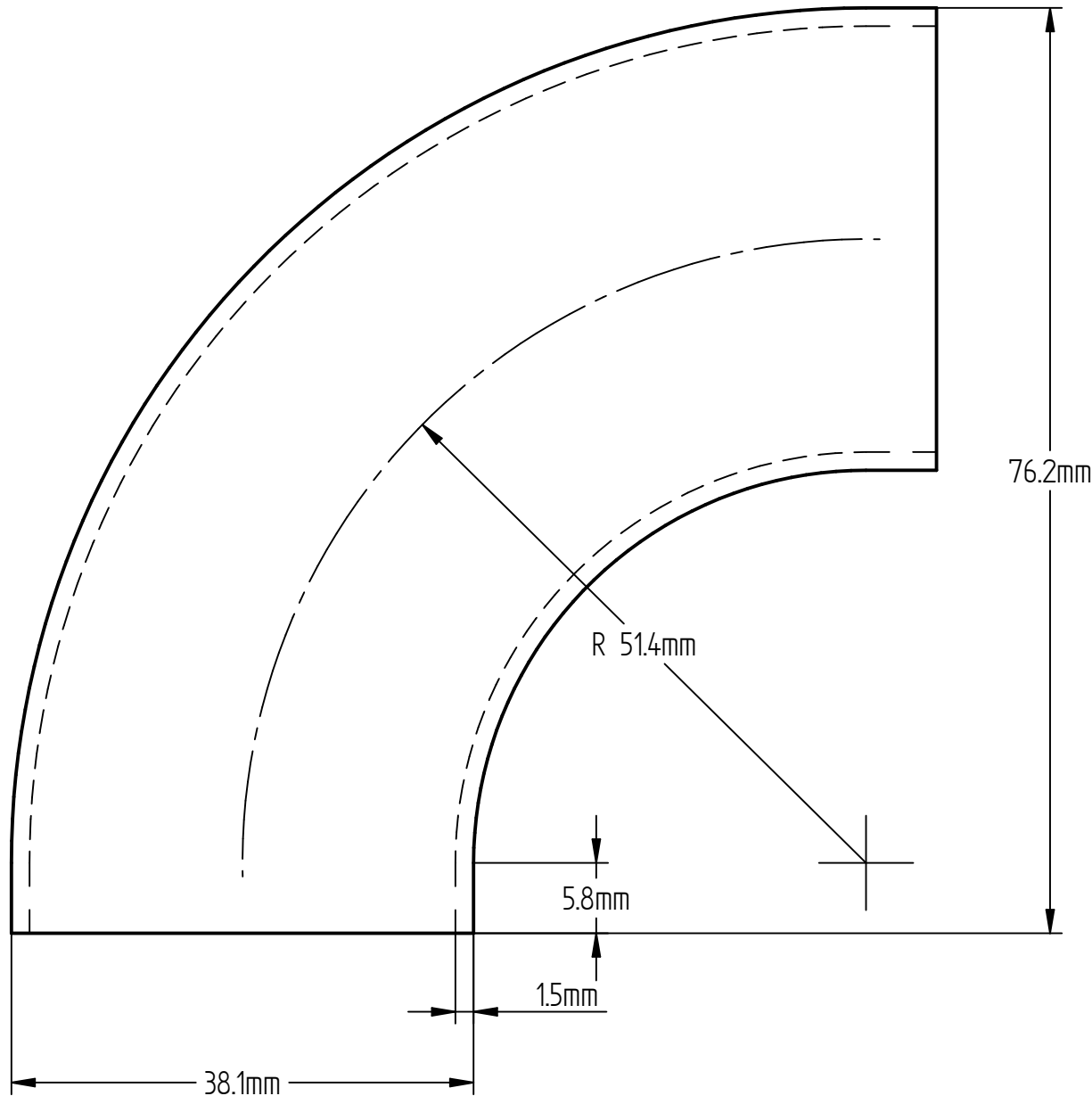

<b>Ultiform</b> BY ULTIBEND		
TITLE 38.1 x 1.5mm 90 degree ZETAN Bend		
SIZE A4	DWG NO 155_9Z	REV 001
		Publish Date: 22/11/24
SCALE:	WEIGHT:	SHEET 1 OF 1