

	Nominal Dimensions	Tolerance
Centreline Radius	79.4mm	Nominal
Overall Height	139.8mm	+1/-0mm
Leg Length	38.1mm	Nominal
Wall Thickness	1.60mm	+0/-0.10mm

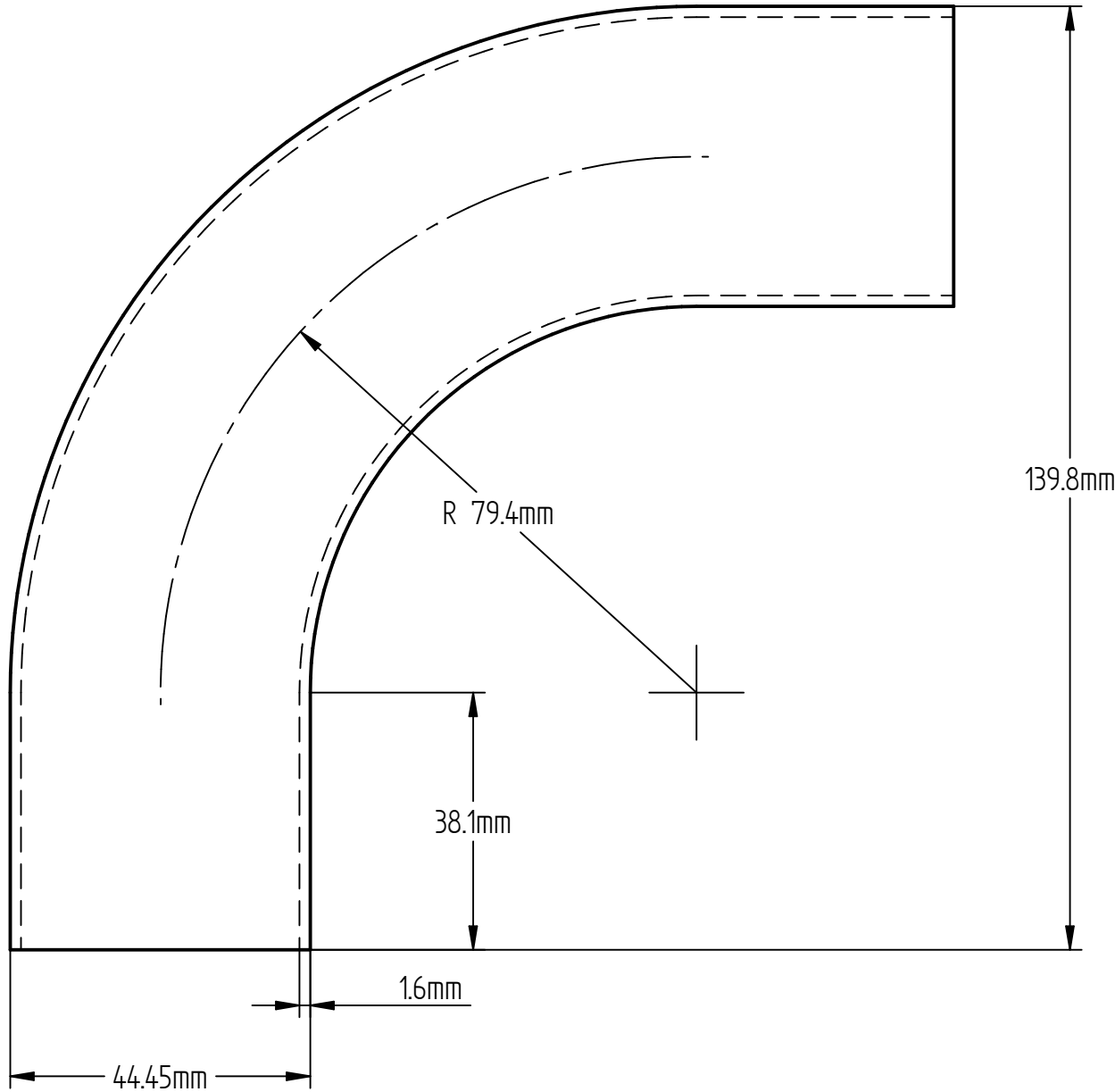

Ultibend INDUSTRIES INC		
TITLE 44.5 x 1.6mm 90 degree NZ Bend		
SIZE A4	DWG NO 176_9N	REV 001
		Publish Date: 11/11/24
SCALE:	WEIGHT:	SHEET 1 OF 1