

	Nominal Dimensions	Tolerance
Centreline Radius	76.2mm	Nominal
Overall Height	131.6mm	+1/-0mm
Leg Length	30.00mm	Nominal
Wall Thickness	1.50mm	+0/-0.10mm

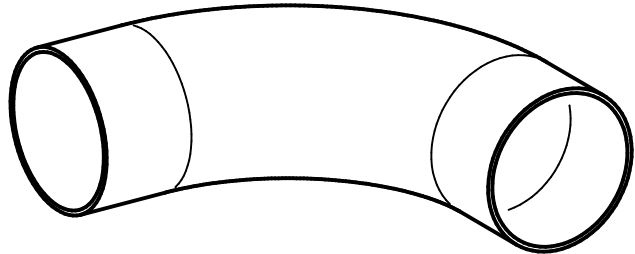
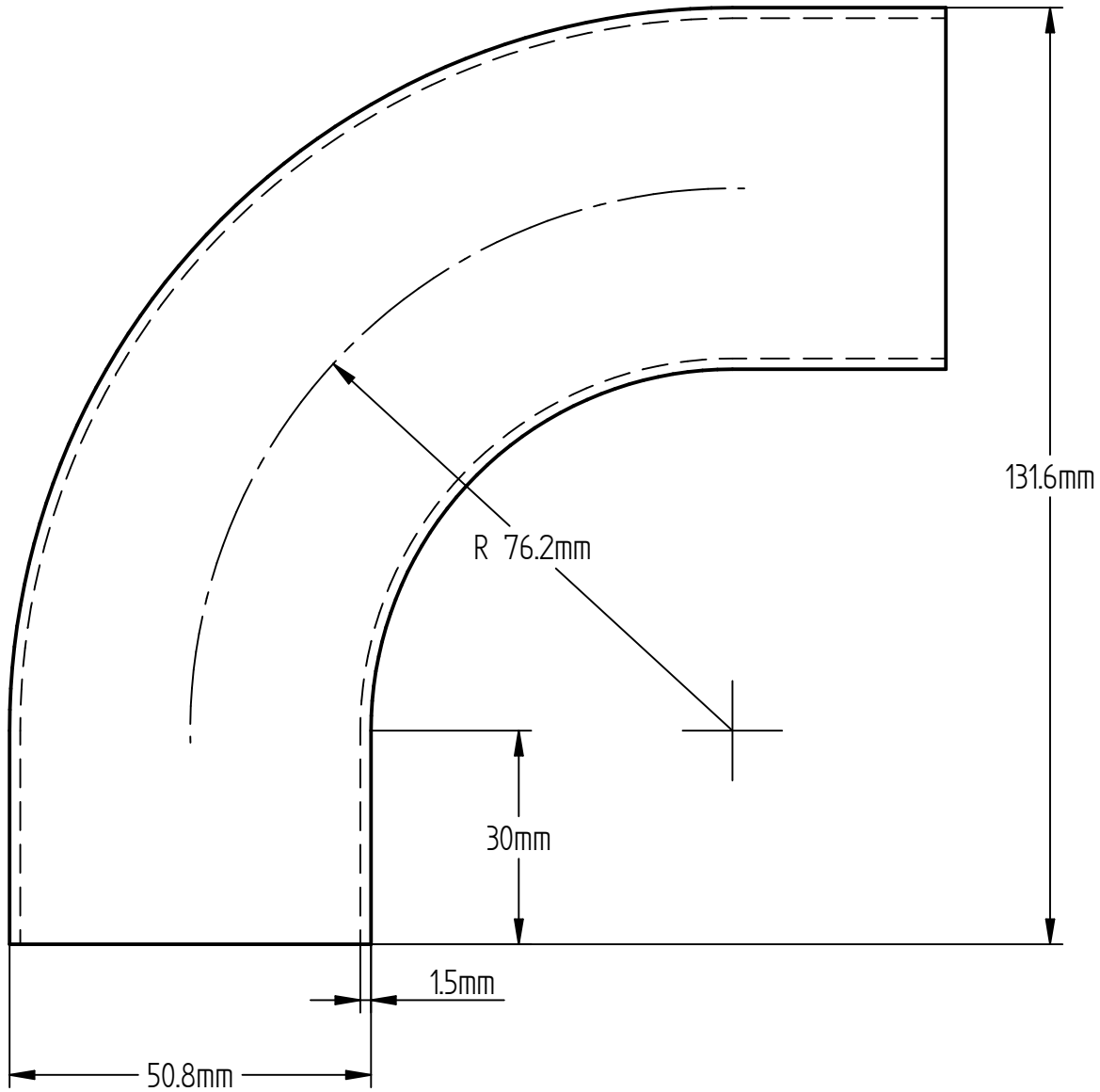

Ultiform BY ULTIBEND		
TITLE 50.8 x 1.5mm 90 degree UNI Bend		
SIZE A4	DWG NO 205_9U	REV 001
		Publish Date: 22/11/24
SCALE:	WEIGHT:	SHEET 1 OF 1