

	Nominal Dimensions	Tolerance
Centreline Radius	85.7mm	Nominal
Overall Height	127.0mm	+1/-0mm
Leg Length	9.5mm	Nominal
Wall Thickness	1.60mm	+0/-0.10mm

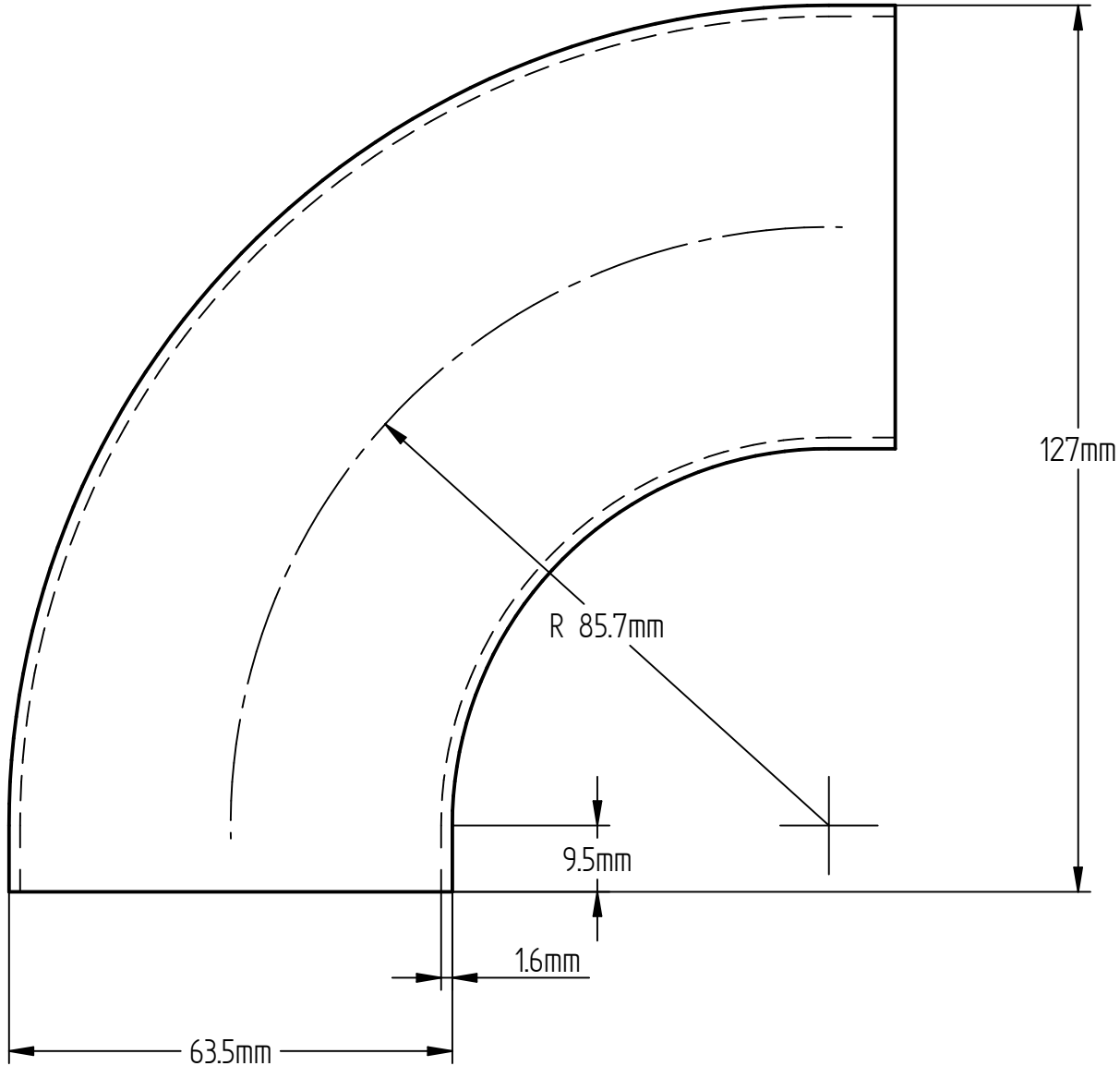

Ultibend INDUSTRIES INC		
TITLE 63.5 x 1.6mm 90 degree Zetan Bend		
SIZE A4	DWG NO 256_9Z	REV 001
		Publish Date: 7/11/24
SCALE:	WEIGHT:	SHEET 1 OF 1