

	Nominal Dimensions	Tolerance
Centreline Radius	139.7mm	Nominal
Overall Height	215.9mm	+/-1mm
Leg Length	38.1mm	Nominal
Wall Thickness	1.60mm	+0/-0.10mm

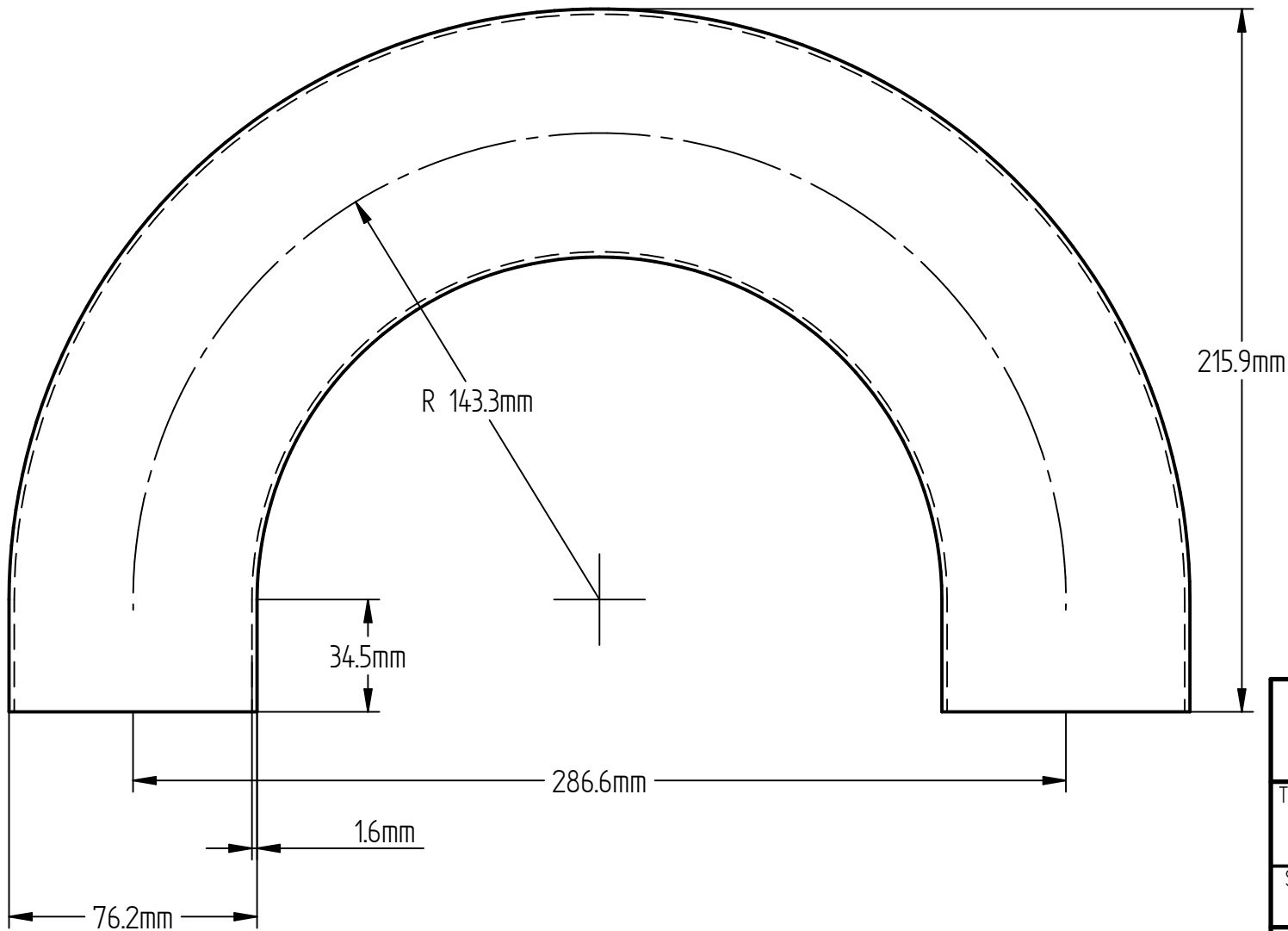

Ultibend INDUSTRIES INC		
TITLE 76.2 x 1.6mm 180 degree NZ Bend		
SIZE A4	DWG NO 306_8N	REV 001
		Publish Date: 25/11/24
SCALE:	WEIGHT:	SHEET 1 OF 1